

16K x 4 Static RAM

Features

- High speed
 - 15 ns
- Output enable (\overline{OE}) feature (CY7C166)
- CMOS for optimum speed/power
- Low active power
 - 633 mW
- Low standby power
 - 110 mW
- TTL-compatible inputs and outputs
- Automatic power-down when deselected

Functional Description

The CY7C164 and CY7C166 are high-performance CMOS static RAMs organized as 16,384 by 4 bits. Easy memory expansion is provided by an active LOW Chip Enable (\overline{CE}) and

three-state drivers. The CY7C166 has an active LOW Output Enable (\overline{OE}) feature. Both devices have an automatic power-down feature, reducing the power consumption by 65% when deselected.

Writing to the device is accomplished when the Chip Enable (\overline{CE}) and Write Enable (\overline{WE}) inputs are both LOW (and the Output Enable (\overline{OE}) is LOW for the CY7C166). Data on the four input/output pins (I/O_0 through I/O_3) is written into the memory location specified on the address pins (A_0 through A_{13}).

Reading the device is accomplished by taking Chip Enable (\overline{CE}) LOW (and \overline{OE} LOW for CY7C166), while Write Enable (\overline{WE}) remains HIGH. Under these conditions the contents of the memory location specified on the address pins will appear on the four data I/O pins.

The I/O pins stay in a high-impedance state when Chip Enable (\overline{CE}) is HIGH (or Output Enable (\overline{OE}) is HIGH for CY7C166). A die coat is used to insure alpha immunity.

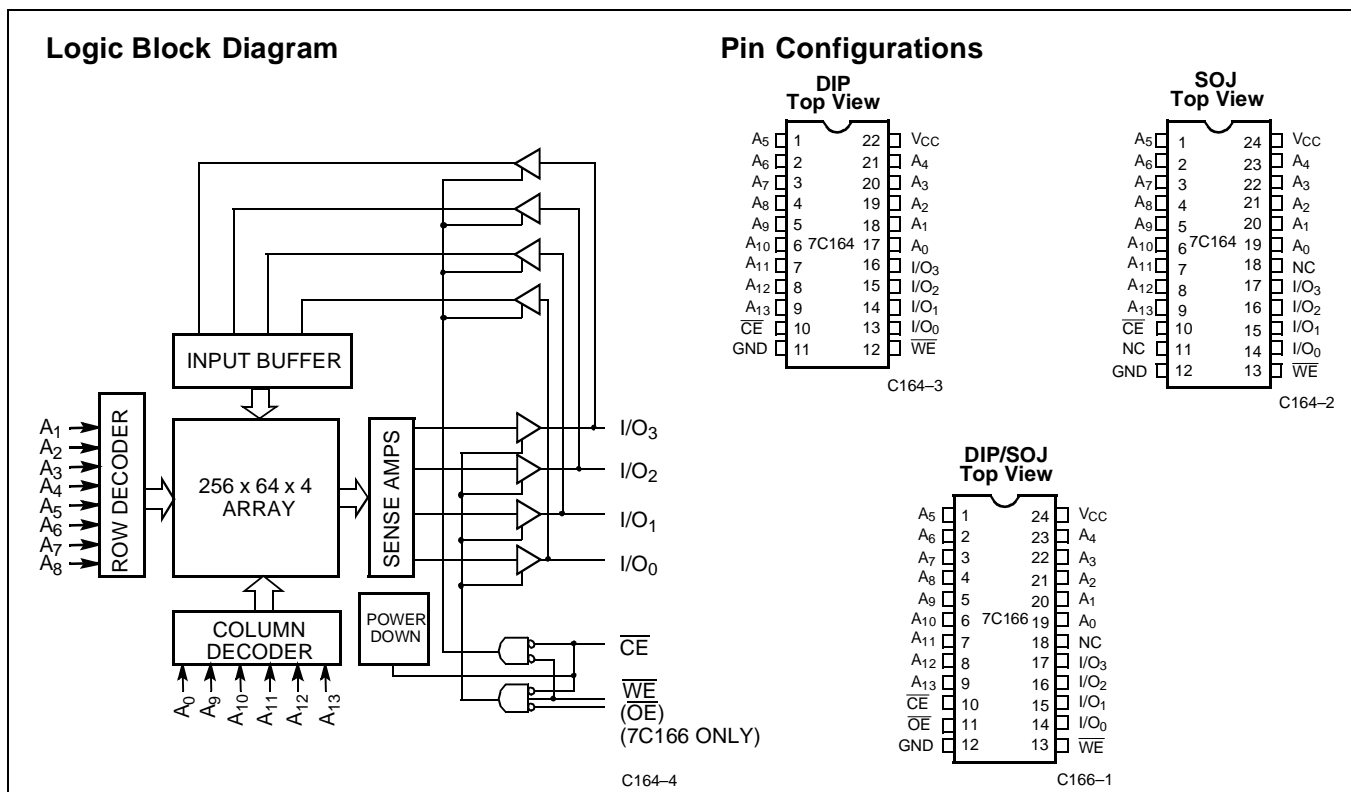

Selection Guide

	7C164-15 7C166-15	7C164-20 7C166-20	7C164-25 7C166-25	7C164-35 7C166-35
Maximum Access Time (ns)	15	20	25	35
Maximum Operating Current (mA)	115	115	105	105
Maximum Standby Current (mA)	20	20	20	20

Maximum Ratings

(Above which the useful life may be impaired. For user guidelines, not tested.)

Storage Temperature	-65°C to +150°C
Ambient Temperature with Power Applied.....	-55°C to +125°C
Supply Voltage to Ground Potential	-0.5V to +7.0V
DC Voltage Applied to Outputs in High Z State ^[1]	-0.5V to +7.0V
DC Input Voltage ^[1]	-0.5V to +7.0V

Output Current into Outputs (LOW).....	20 mA
Static Discharge Voltage	>2001V (per MIL-STD-883, Method 3015)
Latch-Up Current.....	>200 mA

Operating Range

Range	Ambient Temperature	V _{CC}
Commercial	0°C to +70°C	5V ± 10%

Electrical Characteristics Over the Operating Range

Parameter	Description	Test Conditions	7C164-15 7C166-15		7C164-20 7C166-20		7C164-25, 35 7C166-25, 35		Unit
			Min.	Max.	Min.	Max.	Min.	Max.	
V _{OH}	Output HIGH Voltage	V _{CC} = Min., I _{OH} = -4.0 mA	2.4		2.4		2.4		V
V _{OL}	Output LOW Voltage	V _{CC} = Min., I _{OL} = 8.0 mA		0.4		0.4		0.4	V
V _{IH}	Input HIGH Voltage		2.2	V _{CC}	2.2	V _{CC}	2.2	V _{CC}	V
V _{IL}	Input LOW Voltage ^[1]		-0.5	0.8	-0.5	0.8	-0.5	0.8	V
I _{Ix}	Input Load Current	GND ≤ V _I ≤ V _{CC}	-5	+5	-5	+5	-5	+5	μA
I _{OZ}	Output Leakage Current	GND ≤ V _O ≤ V _{CC} , Output Disabled	-5	+5	-5	+5	-5	+5	μA
I _{OS}	Output Short Circuit Current ^[2]	V _{CC} = Max., V _{OUT} = GND		-350		-350		-350	mA
I _{CC}	V _{CC} Operating Supply Current	V _{CC} = Max., I _{OUT} = 0 mA		115		115		105	mA
I _{SB1}	Automatic \overline{CE} Power-Down Current ^[3]	Max. V _{CC} , $\overline{CE} \geq V_{IH}$, Min. Duty Cycle = 100%		40		40		20	mA
I _{SB2}	Automatic \overline{CE} Power-Down Current ^[3]	Max. V _{CC} , $\overline{CE} \geq V_{CC} - 0.3V$, V _{IN} ≥ V _{CC} - 0.3V or V _{IN} ≤ 0.3V		20		20		20	mA

Capacitance^[4]

Parameter	Description	Test Conditions	Max.	Unit
C _{IN}	Input Capacitance	T _A = 25°C, f = 1 MHz, V _{CC} = 5.0V	10	pF
C _{OUT}	Output Capacitance		10	pF

Notes:

1. Minimum voltage is equal to -3.0V for pulse durations less than 30 ns.
2. Not more than 1 output should be shorted at one time. Duration of the short circuit should not exceed 30 seconds.
3. A pull-up resistor to V_{CC} on the \overline{CE} input is required to keep the device deselected during V_{CC} power-up, otherwise I_{SB} will exceed values given.
4. Tested initially and after any design or process changes that may affect these parameters.

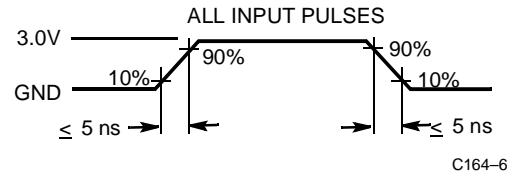
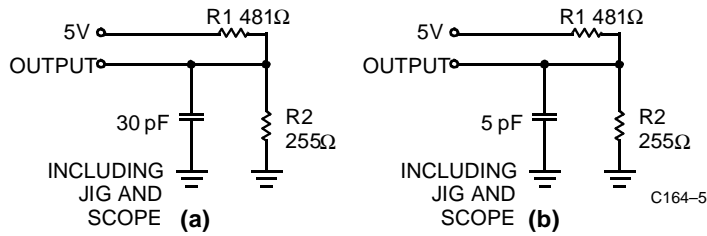
AC Test Loads and Waveforms

Equivalent to: THÉVENIN EQUIVALENT
 OUTPUT — 167Ω — 1.73V

Switching Characteristics Over the Operating Range^[5]

Parameter	Description	7C164-15 7C166-15		7C164-20 7C166-20		7C164-25 7C166-25		7C164-35 7C166-35		Unit
		Min.	Max.	Min.	Max.	Min.	Max.	Min.	Max.	
READ CYCLE										
t _{RC}	Read Cycle Time	15		20		25		35		ns
t _{AA}	Address to Data Valid		15		20		25		35	ns
t _{OHA}	Output Hold from Address Change	3		5		5		5		ns
t _{ACE}	\overline{CE} LOW to Data Valid		15		20		25		35	ns
t _{DOE}	\overline{OE} LOW to Data Valid		10		10		12		15	ns
t _{LZOE}	\overline{OE} LOW to Low Z	3		3		3		3		ns
t _{HZOE}	\overline{OE} HIGH to High Z		8		8		10		12	ns
t _{LZCE}	\overline{CE} LOW to Low Z ^[6]	3		5		5		5		ns
t _{HZCE}	\overline{CE} HIGH to High Z ^[6, 7]		8		8		10		15	ns
t _{PU}	\overline{CE} LOW to Power-Up	0		0		0		0		ns
t _{PD}	\overline{CE} HIGH to Power-Down		15		20		20		20	ns
WRITE CYCLE^[8]										
t _{WC}	Write Cycle Time	15		20		20		25		ns
t _{SCE}	\overline{CE} LOW to Write End	12		15		20		25		ns
t _{AW}	Address Set-Up to Write End	12		15		20		25		ns
t _{HA}	Address Hold from Write End	0		0		0		0		ns
t _{SA}	Address Set-Up to Write Start	0		0		0		0		ns
t _{PWE}	\overline{WE} Pulse Width	12		15		15		20		ns
t _{SD}	Data Set-Up to Write End	10		10		10		15		ns
t _{HD}	Data Hold from Write End	0		0		0		0		ns
t _{LZWE}	\overline{WE} HIGH to Low Z ^[6]	5		5		5		5		ns
t _{HZWE}	\overline{WE} LOW to High Z ^[6, 7]		7		7		7		10	ns

Notes:

- Test conditions assume signal transition time of 5 ns or less, timing reference levels of 1.5V, input pulse levels of 0 to 3.0V, and output loading of the specified I_{OL}/I_{OH} and 30-pF load capacitance.
- At any given temperature and voltage condition, t_{HZCE} is less than t_{LZCE} for any given device. These parameters are guaranteed by design and not 100% tested.
- t_{HZCE} and t_{HZWE} are specified with C_L = 5 pF as in part (b) in AC Test Loads. Transition is measured ±500 mV from steady-state voltage.
- The internal write time of the memory is defined by the overlap of \overline{CE} LOW and \overline{WE} LOW. Both signals must be LOW to initiate a write and either signal can terminate a write by going HIGH. The data input set-up and hold timing should be referenced to the rising edge of the signal that terminates the write.

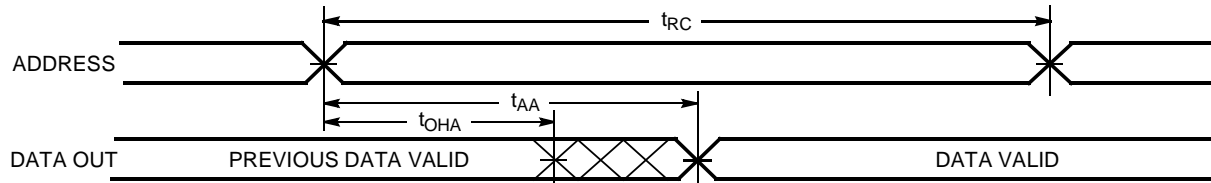
Switching Waveforms
Read Cycle No.1 [9, 10]

C164-7

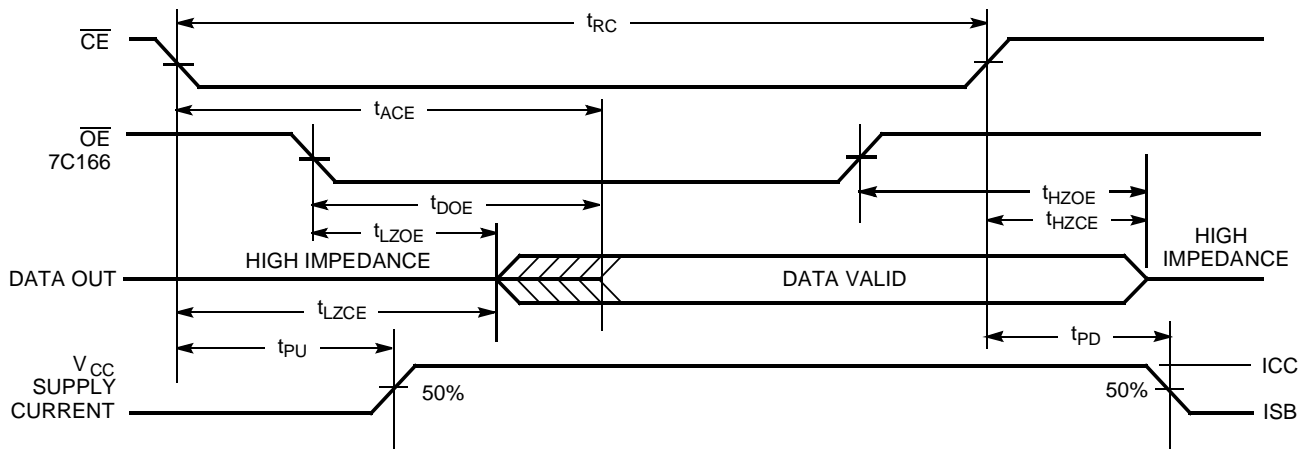
Read Cycle No. 2 [9, 11]

C164-8

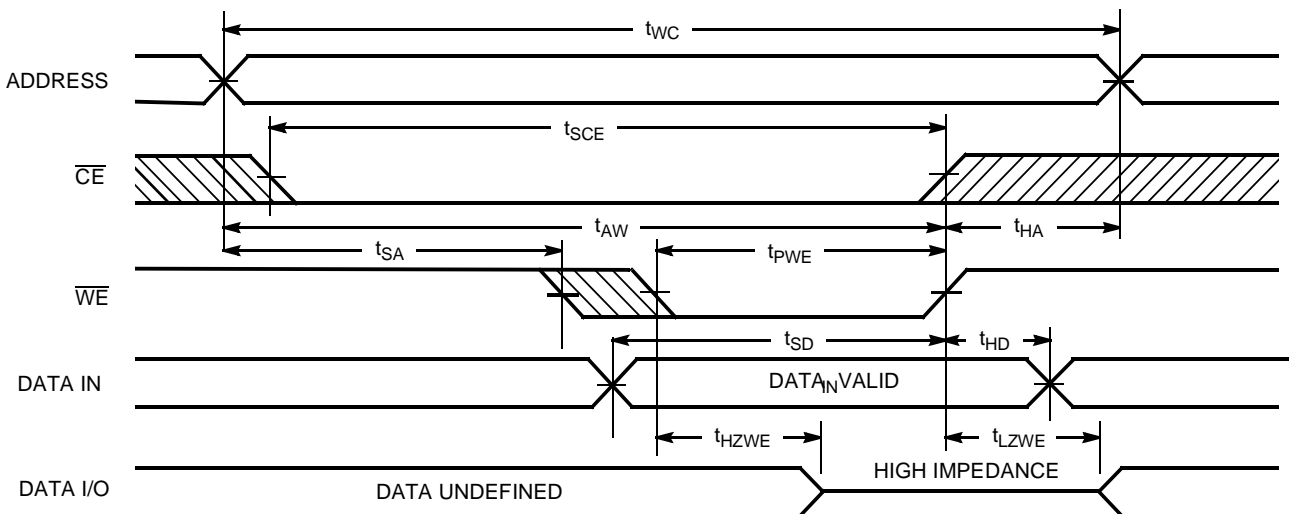
Write Cycle No. 1 (\overline{WE} Controlled) [8, 12]

C164-9

Notes:

9. \overline{WE} is HIGH for read cycle.
10. Device is continuously selected, $\overline{CE} = V_{IL}$. (CY7C166: $\overline{OE} = V_{IL}$ also).
11. Address valid prior to or coincident with \overline{CE} transition LOW.
12. CY7C166 only: Data I/O will be high-impedance if $\overline{OE} = V_{IH}$.

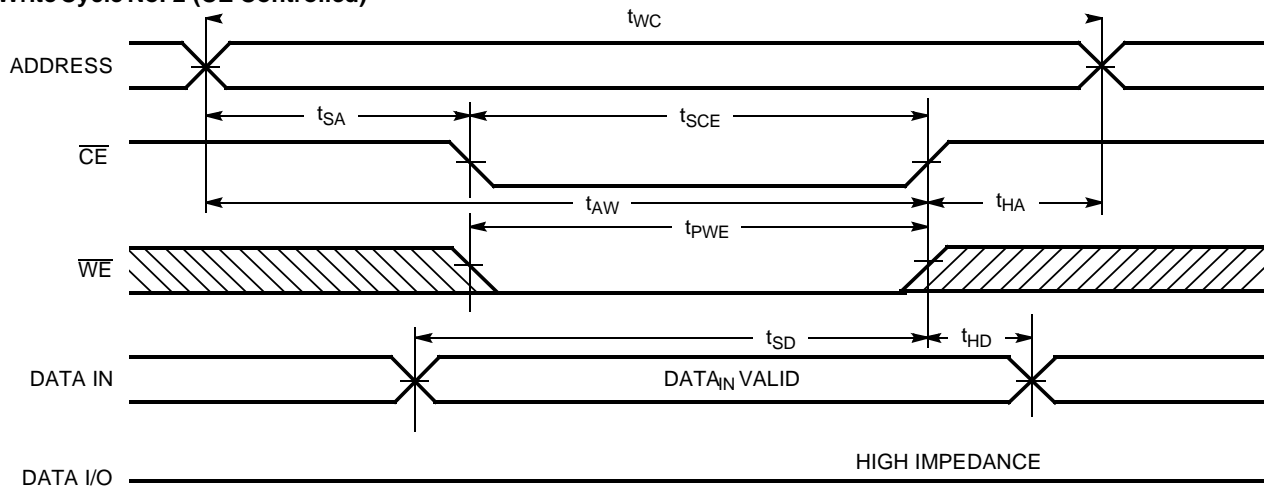
Switching Waveforms (continued)
Write Cycle No. 2 (\overline{CE} Controlled) [8, 12, 13]

C164-10

Note:

13. If \overline{CE} goes HIGH simultaneously with \overline{WE} HIGH, the output remains in a high-impedance state.

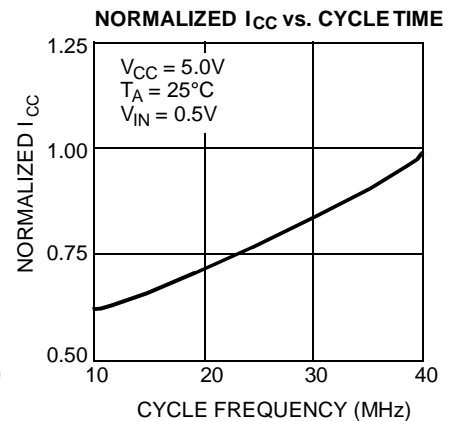
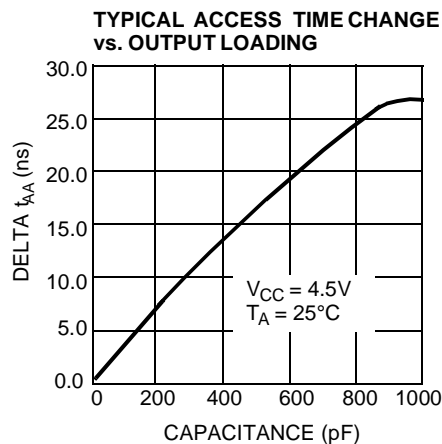
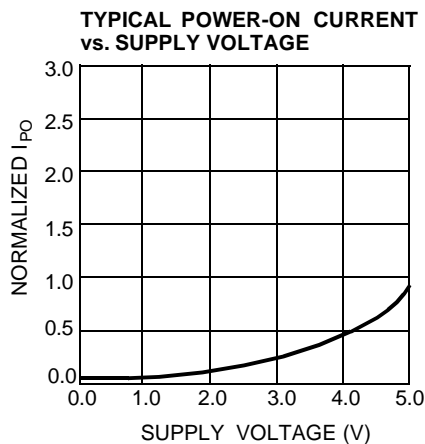
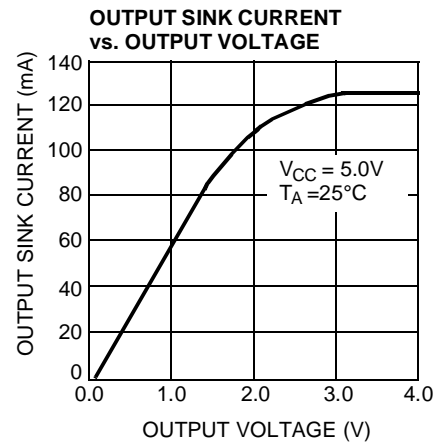
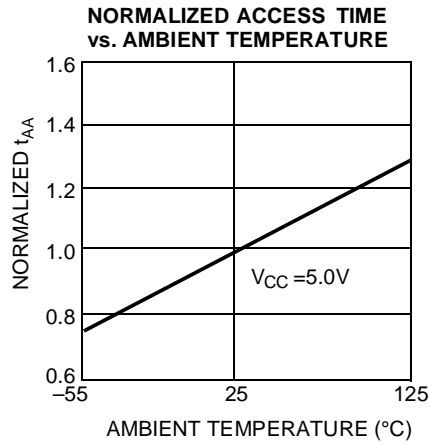
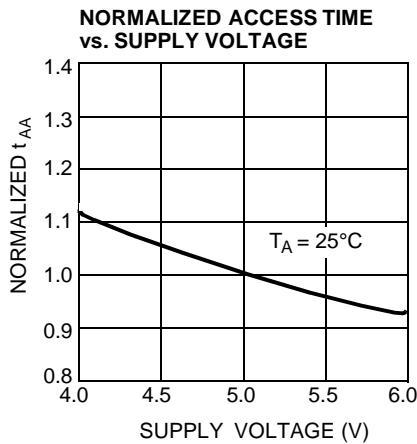
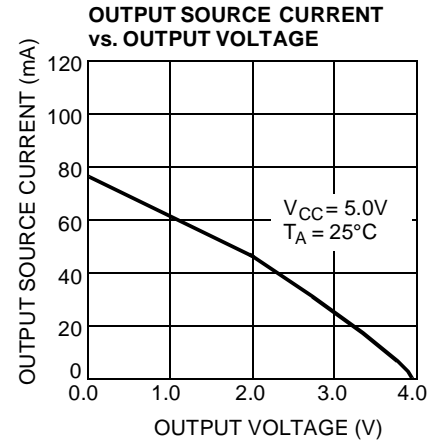
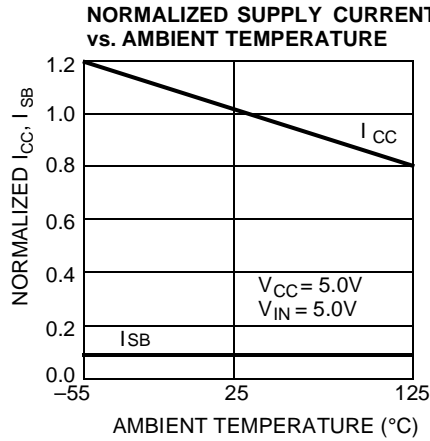
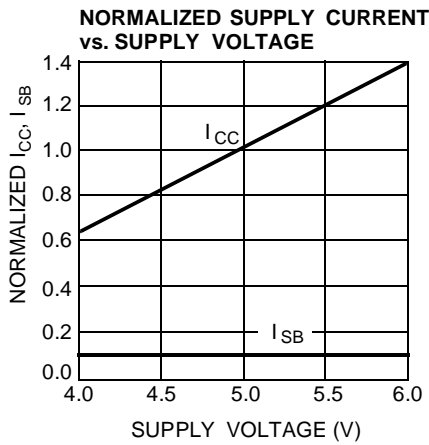
Typical DC and AC Characteristics

CY7C164 Truth Table

\overline{CE}	\overline{WE}	Input/Output	Mode
H	X	High Z	Deselect/Power-Down
L	H	Data Out	Read
L	L	Data In	Write

CY7C166 Truth Table

\overline{CE}	\overline{WE}	\overline{OE}	Input/Output	Mode
H	X	X	High Z	Deselect/Power-Down
L	H	L	Data Out	Read
L	L	H	Data In	Write
L	H	H	High Z	Write

Address Designators

Address Name	Address Function	CY 7C164 Pin Number	CY7C166 Pin Number
A5	X3	1	1
A6	X4	2	2
A7	X5	3	3
A8	X6	4	4
A9	X7	5	5
A10	Y5	6	6
A11	Y4	7	7
A12	Y0	8	8
A13	Y1	9	9
A0	Y2	17	19
A1	Y3	18	20
A2	X0	19	21
A3	X1	20	22
A4	X2	21	23

Ordering Information

Speed (ns)	Ordering Code	Package Name	Package Type	Operating Range
15	CY7C164-15PC	P9	22-Lead (300-Mil) Molded DIP	Commercial
	CY7C164-15VC	V13	24-Lead Molded SOJ	
20	CY7C164-20PC	P9	22-Lead (300-Mil) Molded DIP	Commercial
	CY7C164-20VC	V13	24-Lead Molded SOJ	
25	CY7C164-25PC	P9	22-Lead (300-Mil) Molded DIP	Commercial
	CY7C164-25VC	V13	24-Lead Molded SOJ	
35	CY7C164-35PC	P9	22-Lead (300-Mil) Molded DIP	Commercial
	CY7C164-35VC	V13	24-Lead Molded SOJ	

Speed (ns)	Ordering Code	Package Name	Package Type	Operating Range
15	CY7C166-15PC	P13	24-Lead (300-Mil) Molded DIP	Commercial
	CY7C166-15VC	V13	24-Lead Molded SOJ	
20	CY7C166-20PC	P13	24-Lead (300-Mil) Molded DIP	Commercial
	CY7C166-20VC	V13	24-Lead Molded SOJ	
25	CY7C166-25PC	P13	24-Lead (300-Mil) Molded DIP	Commercial
	CY7C166-25VC	V13	24-Lead Molded SOJ	
35	CY7C166-35PC	P13	24-Lead (300-Mil) Molded DIP	Commercial
	CY7C166-35VC	V13	24-Lead Molded SOJ	

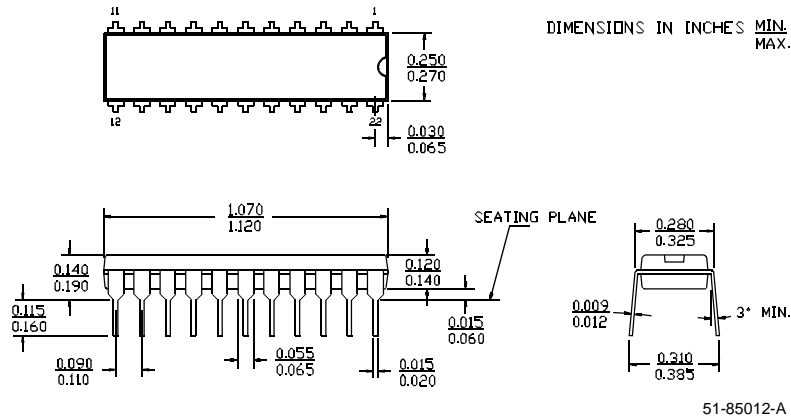
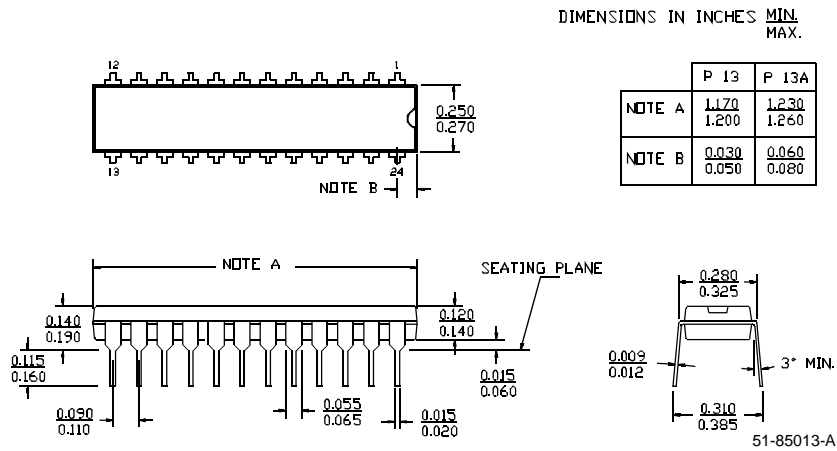
Package Diagrams
22-Lead (300-Mil) Molded DIP P9

24-Lead (300-Mil) Molded DIP P13/P13A

24-Lead (300-Mil) Molded SOJ V13
